

SW2224

LOOP DETECTOR
WITH ASTRA-SWISS-SPECIFICATION

SW2224_BE_10



Content

1	Introduction.....	4
1.1	About this manual.....	4
1.2	Usage according to regulations.....	4
1.3	Label.....	5
1.4	Further documentation.....	5
1.5	Symbols.....	5
1.6	Safety instructions.....	6
2	Product description.....	7
2.1	General.....	7
2.2	Overview of the essential product characteristics.....	9
3	Installation of the SW2224.....	10
3.1	Installation and start-up of the unit.....	10
3.2	Overvoltage protection and loop diagnosis.....	10
3.3	Connection of the feeder cable.....	10
3.4	Parameterizing the traffic data acquisition.....	11
4	Operating the SW2224 with LoopMaster.....	13
4.1	General.....	13
4.2	Functionalities.....	13
5	Display and operating elements at the front panel.....	15
6	Alignment and error diagnosis.....	17
6.1	Alignment.....	17
6.2	Error detection and troubleshooting.....	17
6.3	Automatic calibration and control of vehicle detection.....	19
7	Parameters and functionality.....	21
7.1	Significance of the channel parameters.....	21
7.1.1	Channel function.....	21
7.1.2	Frequency range.....	21
7.1.3	Loop type and loop distance.....	24
7.1.4	Vehicle length correction.....	24
7.1.5	Detection of wrong way drivers.....	25
7.1.6	Address data bus.....	25
7.1.7	Sensitivity / measuring time.....	25
7.1.8	Hold time.....	26
7.1.9	Channel flags.....	26
7.1.10	Maximum loop alignment duration.....	26
7.1.11	Noise threshold.....	27
7.2	Significance of the device parameters.....	27
7.2.1	Language service interface.....	27
7.2.2	Baud rate data bus.....	27
7.2.3	Detector flags.....	27
7.2.4	LED turn-off time.....	27

7.3	Significance of the channel diagnostic values	28
7.3.1	Loop length	28
7.3.2	Extended channel flags	28
7.3.3	Channel status	28
7.3.4	Vehicle classification	28
7.3.5	Channel error	28
7.3.6	Alignment counter and hold time exceedance	28
7.3.7	Inductance	29
7.3.8	Frequency	29
7.3.9	Turn-on threshold, maximum and last amplitude	29
7.3.10	Norm value	29
7.3.11	Alignment cause	29
7.4	Significance of the device diagnostic values	30
7.4.1	Backplane address data bus	30
7.4.2	Front panel switches	30
7.4.3	Reset counter, reset cause	31
7.4.4	Cycle time	31
7.5	Description of the special functions	31
7.5.1	Synchronization	31
7.5.2	Notes concerning the data bus function	32
8	Appendix	33
8.1	General technical data	33
8.2	Technical data of switching outputs	34
8.3	Pin assignment multipoint connector (DIN41612 type F and C)	35
8.4	Pin assignment service interface (DSUB 9-pole, plug)	36
8.5	Dimensions	36
8.6	Requirements for the usage according to regulations	37
8.7	EC Conformity	38

1 Introduction

In this chapter you will find preliminary remarks about the usage of the SW2224, as well as explanations about the structure of this manual and the usage of symbols.

1.1 About this manual

On the following pages you will learn how to install and operate the device in an appropriate way.

We attach great importance to the safe, appropriate and effective handling of this device. It is therefore important to read this manual thoroughly before using the device. In the manual you will find important instructions helping you to avoid danger and to prolong the reliability and durability of the device and the accessories.

For your own safety you should read the safety instructions. Follow the instructions closely in order to avoid danger for yourself and others or damage to the device.

If you have any questions about the SW2224 which are not answered in this manual, or if you have problems understanding the descriptions, please contact:

SWARCO TRAFFIC SYSTEMS GmbH
Business Unit Detection
Niederkircher Straße 16
54294 Trier
Germany

www.swarco.com/sts

1.2 Usage according to regulations

The SW2224 is solely suited for the detection of vehicles for classification and speed measurement. Any further usage is not appropriate. Do not use the SW2224 for any other purpose.



NOTE

The SW2224 is designed for precise vehicle classification and speed measurement in interurban systems for traffic data acquisition and traffic control. It is less suited for urban applications e.g. at traffic light intersections. The conditions for precise vehicle classification such as constant moving are not fulfilled. For these kinds of applications we recommend using detector types from our traffic lights product folio, e.g. IG746CAN (see www.swarco.com/sts/detection).

For further requirements for the usage according to regulations see chapter 8.6.

1.3 Label

The SW2224 is provided with a quality label and serial number. You will need the indications when talking with the customer service, e. g. ordering accessories or spare parts.

Note here the serial number and name of the device in order to have them available when needed:

Serial number: _____

Device identification: _____

This manual is valid for devices with the following order numbers:

- **SW2224T10 (order nr. D.000.611.115): type F connector, open collector, SWISS10 classification, loop type ASTRA, front panel 4 TE**

CE-label:



1.4 Further documentation

- "Loop installation TLS", SWARCO TRAFFIC SYSTEMS GmbH
- "VTD – Vendor-specific telegram definitions", SWARCO TRAFFIC SYSTEMS GmbH
- "Technical delivery terms for roadway stations (TLS)", BASt (German federal highway research institute)
- "Richtlinie Verkehrszähler13012 V1.02 ", ASTRA (Swiss federal roads office)

1.5 Symbols

In several places throughout this manual you will find the following symbols stating important safety instructions:



ATTENTION!

This symbol indicates dangers which might cause damage to people or property



NOTE

This symbol indicates information for installation and function of the device

1.6 Safety instructions

Read the following safety instructions thoroughly and observe them carefully. They are stated to ensure your own safety and the safety of others and to avoid damage to the device or accessories.



ATTENTION!

- **Danger of electricity!**
Make sure that no liquid may get inside the device. If this happens, interrupt the power supply to the device at once.
- If you notice any damage, e.g. broken or crushed cables, damaged plugs, enclosures etc., turn off the device at once, interrupt the power supply and make sure that the device cannot accidentally be turned on again.
- The device may only be installed, brought into service and repaired by an electro-technical expert. Inappropriate operation, improper maintenance or not observing the instructions in this manual can lead to danger.
- Any malfunction of the device which may limit the safety of its users or others must be removed immediately. All warning and safety labels on the device must be observed and kept complete and legible.
- The appropriate usage must be observed by all means. For damage resulting from inappropriate usage the manufacturer will not undertake any liability.
- The device must not be used as a safety component in the sense of the European Directive 98/37/EC ("Machinery Directive"). In systems with high risk additional safety measures are necessary.
- The operator of the device must ensure that the chosen means of operation will not cause damage to material or danger to people and that all security and safety installations are present and functioning.
- Before installation and first operation please observe the instructions in the manual.
- The manual must be available at the site of usage at any time. It must be read thoroughly and applied appropriately by the person responsible for the operation, maintenance and service of the device.



NOTE

- Our products are in a constant process of improvement and advancement. Because of this, read the current manual thoroughly before installation and first operation.
- Without prior consent of the manufacturer, no modifications, neither mechanical nor electrical, may be done. Only parts that have the consent of the manufacturer may be used for backfitting or as accessories. Any violations will lead to the termination of conformity and the manufacturer's warranty. The user will subsequently bear the risk.

2 Product description

2.1 General



The SW2224 is a classification detector operating with two induction loops per lane according to ASTRA-SWISS-specifications.

The SW2224 classifies the vehicles into the ASTRA-SWISS-classes SWISS10, SSSVZ vehicle classes or car-similar / HGV-similar). When using ASTRA-SWISS loops, the classification meets the definitions of ASTRA.

The detection quality is not influenced by e.g. the weather. By activating the directional logic, messages for wrong way drivers can be generated.

The vehicle class is determined by means of the detection curves, which show typical features for the different classes and the loop type used.

The detector can provide the following single vehicle data via RS232 service interface and RS485 data interface:

Single vehicle data:	vehicle class, speed (up to 300 km/h), length, distance, driving direction
Additionally available at data interface:	Interval occupancy and time gap to calculate the occupancy rate; single-vehicle occupancy and time gap
SWISS10-vehicle classes:	motorbike / car / car with trailer / van / van with trailer / van with semitrailer / bus, car / HGV / HGV with trailer / HGV articulated
	The classification into SSVZ vehicle classes resp. car-similar / HGV-similar vehicles is based on the SWISS10 vehicle classes according to ASTRA guidelines.

Table 1: Data of the SW2224 at the service and data interface

Single vehicle data is transmitted via the RS485-bus to a controller, which carries out the further data-aggregation according to ASTRA-specification.

The detector aligns itself automatically to the loops and feed combination connected. Variations in temperature do not affect the data acquisition. The measurement systems are permanently checked for short-circuited or open loops and only put in an error status when a definite malfunction is recognized. If one loop of the TLS double-loop system is defective, the remaining loop still provides time of occupancy, time gap and a classification of car-similar and lorry-similar vehicles. Speed and vehicle length cannot be detected anymore.

Short measurement intervals and a particular speed measurement processes ensure the high accuracy of measurement data and the high detection speed according to ASTRA requirements.

The detector processes the loops one after the other in a predetermined sequence (multiplex mode); i.e. there is always only one loop switched as inductance L to the LC oscillating circuit of the detector. Since there is always only current flow through one loop, the channels of a detector cannot interfere with each other. The channel reaction times and the cycle time of the detector indicated in the technical data result from the multiplex mode.

If a metallic object is located within the range of action of the connected induction loop, the frequency of the LC oscillator also changes owing to reduction in the loop inductance. The detector evaluation circuit determines these changes and generates e.g. vehicle profiles for the classification.

The detector is configured via service interface on the front. The free PC service software **LoopMaster** provides a convenient operator interface for modifying and displaying all parameters and diagnostic values. The configured parameters are stored in a non-volatile memory (EEPROM).



ATTENTION!

The loop detector SW2224 is solely designed for use by qualified personnel trained in dealing with traffic detection equipment. Improper use of the SW2224 may result in unpredictable behavior of the systems controlled by the detector.

2.2 Overview of the essential product characteristics

- Traffic data acquisition and vehicle classification ASTRA-SWISS according to ASTRA for two lanes
- Measurement of speeds and lengths, detection of direction and wrong way drivers by means of double loop systems, occupancy rate in connection with a controller.
- Data interface: RS485 interface at terminal strip
- Service interface: RS232 interface at front
- 4 Open Collector switching outputs with parameterizable function:
 - Detection signals or switching signals depending on vehicle class and/or vehicle speed for the direct control of optical traffic signs with parameterizable blinking frequency and number of pulses.
- Euro-card plug-in (100 mm x 160 mm) for 19"-module carrier, slim design: 20 mm (4 TE) or 40 mm (8 TE)
- Loop control in multiplex mode
- Wide setting range for measurement frequency
- Low power consumption
- Convenient operation by means of PC operating program LoopMaster via RS232, saving of unit-specific or application-specific parameter sets by means of LoopMaster
- Non-volatile storage of all operating parameters in EEPROM (internal or external), a slot-related parameterization can be realized by using an additional external EEPROM at the backplane
 - Advantage: Parameter transfer allows simple device exchange
- System parameters, e.g.:
 - Frequency
 - Hold time
 - Loop distance
- Channel diagnosis values, e.g.:
 - Measurement frequency
 - Loop inductance
 - Failure type
- Permanent loop control for immediate detection of inductive loop failures
- Automatic compensation of temperature influences and ferrite control
- High interference resistance by means of frequency adjustment, oversampling and possibility of detector synchronization
- Automatic alignment after activation, reset or parameter modification
- Automatic recalibration in case of malfunction
- μ -controller with watchdog and power fail monitoring
- Special options:
 - Potential free switching outputs (electronic relays)
 - Traffic data acquisition and vehicle classification with single loops¹ for 4 lanes

¹ Without speed and length measurement, no recognition of driving direction (not possible for CD9234)

3 Installation of the SW2224

3.1 Installation and start-up of the unit

The SW2224 is designed for installation in 19" racks with plug connectors according to DIN41612 (type F or C). Wire the racks according to the terminal assignment in the appendix. When connecting the loops, all feeder cables must be twisted both inside the control cabinet and the rack! Do not use the feeder cables parallel to e.g. AC-power supply or communication cables! The loop installation manual by SWARCO TRAFFIC SYSTEMS GMBH must be observed (available on request).

Refer to the technical data for the specification of the supply voltage.



ATTENTION!

There is **no** inverse polarity protection for the power supply connection (d32/z32).



ATTENTION!

Incorrect connection of the unit may result in malfunctions or destruction of the unit. SWARCO TRAFFIC SYSTEMS GMBH does not provide any warranty coverage for unit function in case of incorrect installation and cannot be held liable in this case. The general electro-technical rules must be complied with when connecting the detector.

After switching on the unit for the first time, the detector aligns to the connected loop inductance. Short-circuited or open loop connections are indicated by the **ERR** (ERROR) collective error LED and flashing of the channel LED of the disturbed channel (see also chapter 6.2). The **FCT** (FUNCTION) LED flashes during normal operation with a frequency of 1 Hz.

3.2 Overvoltage protection and loop diagnosis

The detector has a basic overvoltage protection at the loop inputs. Additional overvoltage protection measures must be applied in order to provide multistage overvoltage protection. For this purpose, an overvoltage protection element such as FP_V1_3 by SWARCO TRAFFIC SYSTEMS GMBH can be mounted on a DIN rail in the control cabinet. This protection element is adapted to the medium protection (backplane) and the fine protection (detector).

Under no circumstances should varistors or suppression diodes be used, as these may have a negative effect on detector function.

Before the detectors are installed, the loop values must be checked. The values for loop inductance, ohmic resistance and insulation resistance should be checked and documented.

For more information about loop installation see the manual "Loop installation TLS".

3.3 Connection of the feeder cable

For short distances between detector and induction loop up to approx. 15 m, the feeder cable can be directly connected to the feeder clamps. The loop feeder cable must be drilled approx.

20 – 50 times per meter.

For longer distances to the roadside station, we recommend using an outdoor telephone cable type A-2Y (L) 2Y resp. A-2YF (L) 2Y (see also chapter 8.1). Please also observe the according information about loop connection and cable types to be used stated in the TLS.

In order minimize the coupling of channels caused by a shared feeder cable, both channels of a measurement system **must** be connected to the opposing leads of a star quad (e.g. channel 1: 1a – 1b and channel 2: 2a – 2b).

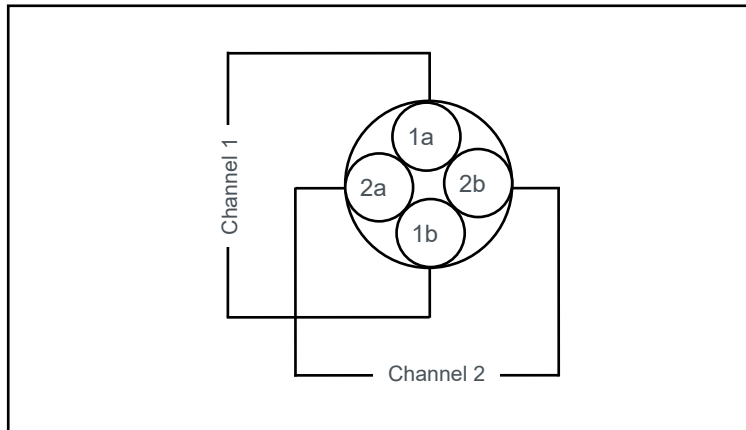

Figure 2: Connection of the inductive loops in a star quad of cable type A-2Y (L) 2Y



NOTE

With the SW2224, for feed cable lengths up to 300 m and the indicated cable type only one pair of wires per loop is necessary in the feed cable. No expensive double pair of wires – often impossible in existing systems – is needed.

For feeder cable lengths > 300 m, a double pair of wires per loop can also be used (please inquire). Here, a star quad is used per channel. The parallel wiring of 1a / 1b and 2a / 2b reduces the ohmic resistance of the feeder cable by half, the inductance of the feeder cable is reduced to approx. 25 % of the value using one pair of wires.

3.4 Parameterizing the traffic data acquisition

In order to parameterizing the traffic data acquisition, the following settings in the LoopMaster operating program must be done in the indicated order:

- Turn on the measurement system: see chapter 7.1.1
- Address of traffic data acquisition system at the RS485 data interface: see chapters 7.1.6 and 7.4
- Check consistency of loop type used acc. to ASTRA-SWISS definitions and detector parameter loop type, if necessary, correct loop head distance: see chapter 7.1.3 and 7.3.1
- Frequency adjustment: see chapter 7.1.2
- Detection of wrong way drivers, directional logic (only if necessary): see chapter 7.1.5
- Length correction (only if necessary): see chapter 7.1.4

Malfunctions, indicated at the **ERR** LED are displayed in the LoopMaster operating program and can be determined by the blinking of the channel LED with the help of Table 2. If operation is faultless, the correct function of the traffic data acquisition should be checked on location using single vehicle data after having detected a minimum of approx. 50 cars. Classification, vehicle length and driving direction can be controlled by monitoring cars passing the loop system and comparing them with the vehicle data read out at the service interface (see chapter 6.3).
An exact evaluation of speeds can only be done by means of a calibrated speed reference (e.g. laser / radar gun).

4 Operating the SW2224 with LoopMaster

4.1 General

The SW2224 is operated via service interface on the front by means of the LoopMaster operating program installed on a PC or laptop computer. The detector is connected directly with the COM port of the PC or alternatively via USB port and standard COM-USB adapter.



NOTE

- Please use a 9-pole (1:1)-DSUB standard cable (plug-plug) as connection cable. SWARCO TRAFFIC SYSTEMS GMBH label KA_V746 (order number: D.000.603.296).
- The connection cable used with the preceding model MC2024 and the TTL-RS232 adapter is not needed anymore.
- Due to the new operating concept of LoopMaster, the service terminal used with the preceding model MC2024 cannot be used anymore. The reason for this is the harmonization of the service interfaces for all detectors of the “Weiss-Electronic“ brand.
- Please use the LoopMaster program only, the preceding program IGBT does not support this detector type.

In the LoopMaster program the following interface parameters can be set: (**Settings – Communication settings...**):

- COM port
- Baud rate: 4800 Baud (default)

The LoopMaster program provides an extensive help function, therefore only the most important functions will be described in the following.

The LoopMaster software is available as download from our website under www.swarco.com/products/software/other-software

4.2 Functionalities

In the parameter and diagnosis windows of LoopMaster the parameter and diagnosis values used in the SW2224 are displayed as clear text. There are windows for individual channels, normally 4 in the SW2224, and one detector window. The detector window lists the according values for several channels and / or of the complete device. The data of these values between LoopMaster and SW2224 is transferred together with the channel values.

The displayed values in the channel and detector windows are classified into alterable parameter values and unalterable diagnosis values. The entry fields for the alterable parameters are white, the display fields for the diagnosis values are grey.

Besides these windows a terminal window is located at the left side of the LoopMaster program which logs the serial communication via service interface. In this window also all current vehicle data are listed.

When the LoopMaster program is started, all channel and detector data are automatically requested and displayed in the according windows, the status bar at the bottom part of the window is updated.

SW2224 SN123456 E Jul 23 2011 V1.08 LC22

Figure 3: Example for the LoopMaster status bar

The displayed information are used to identify the detector hardware and firmware:

- Detector type, e.g. SW2224
- **Serial Number**, e.g. SN123456
- Country code of the service interface output, e.g. E (English) or D (German)
- Detector firmware date, e.g. Jul 23 2011 (23.07.2011)
- Version status of the detector firmware, e.g. V1.08 (Version 1.08)
- Identification for the detector-specific display in LoopMaster, loop configuration, e.g.: LC22: 2 loop systems with 2 double loops each

Opposite to detectors for traffic light systems, the SW2224 is normally used as double loop detector, i.e. in order to function a loop system with 2 inductive loops arranged successively is necessary. Channels 1 and 2 form the first loop system, channels 3 and 4 the second loop system.

This makes no difference in the operation of the LoopMaster program: the 4 channels are separately listed. However, please pay attention to the following notes.



NOTE

- In order to parameterize a double loop system, the windows of the according first channel are used. Alterable parameters are thus only available for channel 1 resp. channel 3.
- The detector automatically adopts the correct parameters for the according second channel of the loop system. The parameters of the channels 2 resp. 4 cannot be altered.
- The diagnosis values of the channels are still displayed individually.

5 Display and operating elements at the front panel

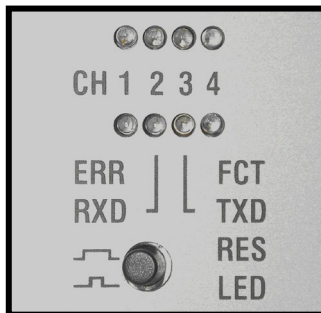

Figure 4: LEDs and pushbuttons at front panel of SW2224

The detector has an LED for each channel to indicate vehicle detection (**CH1...CH4**). Furthermore, in case of a malfunction, the LEDs display the cause of the malfunction (e.g. loop open) by means of a predetermined number of LED blinkings (see chapter 6.2).

The **ERR** LED is activated in case of a malfunction of at least one channel.

The reception and transmission processes of the RS485 data bus interface are indicated at the **RXD** and **TXD** LEDs for the reception and transmission direction of the SW2224 .

The **FCT** LED flashes with a frequency of 1 Hz during normal operation of the detector. With activation of MASTER-SLAVE synchronization, the flashing frequency during normal operation is reduced to 0.5 Hz.

The **RES** LED pushbutton has 3 functions, depending on how long the button is being pushed:

- **LED on / off:** Press button less than 1 sec,
all LEDs are deactivated or activated,
function can be disabled by means of the parameter
setting "LED-turnoff-time = 0"
- **Channel alignment:** Press button 1 – 2 s,
initialization of all active loop channels
- **Reset:** Press button longer than 3 s,
detector reset and subsequent alignment of all channels

All detector settings are made using the front RS232 interface (labeled: "**SERVICE**").



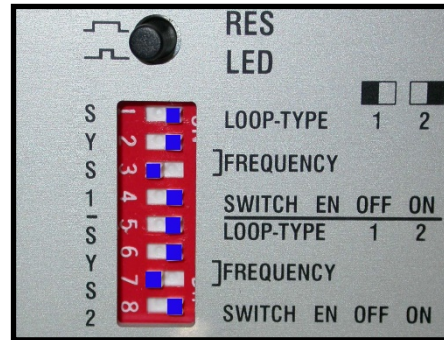

In the standard Version of the des SW2224 (2 double loop systems K1 / K2 and K3 / K4), the parameter frequency range can additionally be adjusted at the DIP switch on the front. For most applications this is the only adjustment to be made and there are no further adjustments necessary e.g. via LoopMaster.



In order to do these adjustments, use the according 4 switches for each loop system:

- The 4 switches on top for loop system 1 with channel 1 and 2
- The 4 switches at the bottom for loop system 2 with channel 3 and 4

Function of the DIP switches:

DIP-switch	Loop system (channel)	Function	Switch position	
			left (OFF)	right (ON)
1 5	1 (1 / 2) 2 (3 / 4)	Loop type*	SWISS10	TLS type 2
2 3 6 7	1 (1 / 2) 2 (3 / 4)	Frequency range	 Frequency range 1 (30 – 44 kHz)  Frequency range 2 (45 – 64 kHz)  Frequency range 3 (65 – 84 kHz)  Frequency range 4 (85 – 110 kHz)	
4 8	1 (1 / 2) 2 (3 / 4)	Activation switches 1 – 3 Activation switches 5 – 7	Not activated**	activated***

*: The loop type to be used depends on the installed firmware version. Only one loop type is valid. Therefore, this switch is only used to display the loop type and not to parameterize it. If a loop type is selected which is not supported, an according error message will be displayed: The **ERR** LED will be on and the channel LED will be blinking 8 times. Moving the switches will always result in an alignment of the allocated loop system. In order to use a loop head distance different from the standard value, the switches must be disabled.

** : Parameterizing of frequency via interface possible.

***: Parameterizing via interface disabled.

6 Alignment and error diagnosis

6.1 Alignment

Alignment is defined as initialization of a detector channel. In doing so, all settings are configured according to the parameters saved in the EEPROM (e.g. frequency, sensitivity). There must be no extended vehicle passages during the alignment. If a convoy of vehicles passes during alignment, the SW2224 attempts to adjust to the gaps between the vehicles. There are no vehicle detections possible during the alignment. After the alignment, the channel is always in an "undetected" status.



ATTENTION!

When a channel is aligned, vehicles located within the range of action of the induction loop at this point in time are ignored. This means that they are not detected during and after the alignment!

In the following events, the SW2224 carries out an alignment:

- after switching on the supply voltage (**Power On Reset "POR"**)
- as a result of modification of relevant parameters (e.g. frequency, loop type, channel function) via service or data interface
- as a result of pushing the RESET button
- as a result of an external RESET signal on the terminal strip (0 V on RESET external, pin d28)
- as a result of an internal RESET (e.g. watchdog or power fail).

After RESET, all activated channels are aligned. When prompted by a parameter transfer via service interface by means of LoopMaster or RS485 bus, only the selected channels for which at least one parameter has changed are realigned. All other channels continue to operate without any influence on their detection in this case. The alignment takes approx. 1 sec. with an unaffected induction loop and may take longer e.g. with disturbances on the loop. The corresponding channel LED **CH1** ... **CH4** is activated during the alignment and additionally the **FCT** LED flashes faster (approx. 5 Hz). Once alignment has been successfully completed, the channel LEDs **CH1** ... **CH4** are switched off and used for the indication of the detection status.

6.2 Error detection and troubleshooting

Channel-related errors are indicated at the channel LEDs **CH1** ... **CH4** by blinking repeatedly every 5 s with a predetermined number of blinkings for each error.

Channel errors	Number of channel LED blinkings
Short-circuit loop	1
Open loop, loop broken	2
Frequency not adjustable	3
Disturbance	4
Frequency jumper faulty	5
Maximum loop alignment duration exceeded	7
Loop type incorrect	8

Table 2: List of channel errors with allocation of the number of flashes to the channel LED

These errors are displayed in the channel windows in the LoopMaster as "channel error" diagnostic parameters (see chapter 7.3.5). Furthermore, the **ERR** collective error LED and the corresponding switching output on the terminal strip indicates an error status with at least one channel.

In case of a short-circuited or open loop, the alignment algorithm detects that the connected inductance (induction loop + feeder cable!) is outside the permissible range (see chapter 8.1). The error cause is to be found and eliminated.

If the selected frequency range cannot be set, the loop inductance lies outside the recommended range (see chapter 8.1). To solve this problem, set another frequency range (see chapter 7.1.2).

The loop frequency can be further influenced by modifying 2 plug jumpers (marked **f**, and **LOW / HIGH**, position in top centre of board). Both jumpers are in the LOW position (lower frequency) in the delivered default condition. The alignment frequency is generally raised by approx. 15 % - 20 % in the HIGH position (higher frequency). Using this, in case of the error message "Frequency not adjustable" for example, another of the upper frequency steps can be released again. Furthermore, in case of frequency overlaps in installations with several SW2224 devices, an additional frequency offset for improved frequency separation can be performed. Both jumpers must be plugged into the same LOW or HIGH position, otherwise the SW2224 will detect this with the error message "Frequency jumpers faulty" for all channels.

The error message "Disturbance" indicates external interferences during alignment. This causes longer alignment times (more than approx. 2 s per channel). The external interferences must be determined and eliminated in order to ensure the correct detector function. Otherwise, misdetections may occur, i.e. the according channel switches even without loop attenuation. The external interferences may be caused by electromagnetic fields or pulses in the environment of the induction loop or feeder cable. Selecting another frequency range may solve this problem.

If the disturbances are caused by other identical loop detectors, the interference can be eliminated by synchronizing the detectors by means of the synchronization leads of the terminal strip (see chapter 7.5).

The duration of the channel alignment is restricted to the set duration using the "maximum loop alignment duration" parameter. The error message "maximum loop alignment duration exceeded" is generated if this time is exceeded.

After troubleshooting, an alignment of all channels or a reset of the SW2224 with subsequent alignment of all channels can be initiated using the pushbutton on the front panel in order to restore correct functionality.

If the channel flag "Automatic recalibration in case of channel error" (see chapter 7.1.9) is activated (factory setting: deactivated), a cyclical alignment is performed in case of a channel error. At the latest 1 min. after troubleshooting, the channel faults will automatically be removed in this case, except for the following faults:

- Frequency jumper faulty
- Loop type incorrect

In this case also, a vehicle located within the range of action of the loop at the time of troubleshooting will be ignored.

If one loop of a double loop system is faulty, the other loop works in standby operation. A high-quality classification (e.g. ASTRA-SWISS10) is not possible anymore, because vehicle lengths and speeds cannot be determined. The classification will automatically be reduced to car-similar / HGV-similar vehicles. In order to reach the original data acquisition quality, the failure cause must be eliminated.

6.3 Automatic calibration and control of vehicle detection

The SW2224 is delivered with standard parameter values optimized for the permitted loop and feeder cable configurations. In order to further optimize the single vehicle detection, important characteristic values e.g. norm value and switch-on threshold resp. sensitivity for the connected loop / feeder cable configuration are permanently and automatically evaluated and stored non-volatile in the EEPROM. Thus, a power failure or reset does not influence the already reached detection quality.

The adjustment of the sensitivity is not possible, since the response thresholds for the vehicle detection are permanently evaluated by using the norm value. The automatic alignment usually has achieved sufficient accuracy after a detection of approx. 50 cars.

Afterwards, a control of the single vehicle detection can be done by visually comparing the vehicles with the data readouts at the service interface on the front. To do so, the LoopMaster terminal window or any terminal program can be used. The following data are displayed separated by detection system:

- Vehicle class
- Vehicle speed
- Vehicle length
- Driving direction
- Vehicle distance

Examples:

- **sy.2 l: 4,31 m v: 75,6 km/h di.0 dis.:910 m car**

Detection system 2 (channel 3 / 4): vehicle class car, length 4.31 m, speed 75.6 km/h, driving direction 0 \equiv loop 3 \rightarrow 4, distance 910 m

- **sy.1 l: 7,97 m v: 60,5 km/h di.1 dis.: 87 m lorry**

Detection system1 (channel 1 / 2): vehicle class lorry, length 7.97 m, speed 60.5 km/h, driving direction 1 \equiv loop 2 \rightarrow 1, distance 87 m

- **sy.1 l: 5,21 m v: 54,3 km/h di.0 dis.: 14 m delivery van**

Detection system1 (channel 1 / 2): vehicle class delivery van, length 5.21 m, speed 54.3 km/h, driving direction 0 \equiv loop 1 \rightarrow 2, distance 14 m

With the standard width of the terminal window (16 characters) the traffic data is displayed in 4 rows per vehicle. When the width is set >63, the data is displayed in one row per vehicle.

Afterwards, the norm value should be checked (LoopMaster: channel diagnosis value). The norm value is different for each loop type and is mainly determined by loop length and installation depth. Also, the norm value is reduced when the length of the loop feeder cable is increased. Typical values for the norm value with common loop types depending on the feeder cable lengths are indicated in the following table:

Loop type*	Feeder cable length [m]**	norm value permitted tolerance: + 10 % / - 20%
TLS type 1 (loop length 2.5 m)	0	2.7 %
	300	1.8 %
TLS type 2 (loop length 1.0 m)	0	1.5 %
	300	1.0 %
ASTRA-SWISS (loop length 2.0 m)	0	2.5 %
	300	1.6 %

*: Installation depth approx. ca. 5 – 7 cm

** : Cable type and connection according to chapter 3.3

Table 3: Typical norm values

If you notice strongly diverging values or big differences between the loops of a double loop system, the quality of the data may be reduced. Reasons for this can be e.g. metallic objects in the area of the inductive loops.



ATTENTION!

For the precise and reliable vehicle detection, a homogenous (uninterrupted) magnetic field in the loop area is indispensable. Metallic components such as manhole covers and reinforcement in concrete carriageways as well as the installation of inductive loops in bridges with metallic fundaments can have a negative influence on the quality of the vehicle detection.

Without these influences and with correctly installed inductive loops, the difference of the norm value between the loops of a double loops system is usually less than 3 %. For the exemplary reference value for TLS type 2 without additional feeder cable from Table 3 this is 1.45 % and 1.55 % as norm values of the two loops. Further reasons for bigger differences are different installation depths, number of windings or loop dimensions.

7 Parameters and functionality

The parameters are divided into

- Channel and/or loop system related parameters (frequency etc.), can be configured separately for each channel. In the following “channel” will also be used for a (loop) system consisting of 2 channels.
- Device parameters (e.g. synchronization), are settings which apply to the entire device (refer to section 7.2)

In addition to the user-adjustable parameters, the SW2224 also provides diagnostic data, which can be displayed in the LoopMaster. These values cannot be directly modified but result from the parameters (e.g. frequency from configured frequency range), are determined during operation (e.g. last amplitude) or result from the unit operating status (e.g. channel status, RESET counter). It is to be noted that all displayed data show the current status of the detector at the time of parameter request (LoopMaster menu item: "Read parameter").



ATTENTION!

The user must take care that the configured parameters ensure a logical and reliable detector function.

7.1 Significance of the channel parameters

The channel parameters comprise all channel-specific settings. After the data transfer to the detector, the detector checks all parameters for modification in comparison to the current settings. An alignment is only performed if at least one of the channel parameters has changed and the modified values are stored non-volatile in the EEPROM. Changes in the parameters which have no influence on the acquisition of measurement values do not cause a new alignment (e.g. length corrections). In a double loop system usually both channels are initialized.

7.1.1 Channel function

The channel function enables or disables channels. This can e.g. be used to switch off channel no longer required or to disable the traffic data acquisition at faulty inductive loops.

7.1.2 Frequency range

The loop frequency of each channel can be set to one of four frequency ranges.

Frequency level	Frequency range [kHz]
'0'	30 - 44
'1'	45 - 64
'2'	65 - 84
'3'	85 - 110

Table 4: frequency levels and ranges, factory setting (bold)

This can contribute to interference suppression during operation of several detectors interconnected by means of loops and / or a loop feeder cable (see **Instructions for setting the frequency with several detectors**)

With a known frequency of external interference sources, interference suppression can likewise be achieved by selecting an appropriate frequency range. The channel is faulty, if the selected frequency range cannot be set (see also chapter 6.2).

The oscillator of the SW2224 is designed in such way that, when using loops with inductances within the recommended range, all frequency ranges can be used (see chapter 8.1).

In the standard version of the SW2224 (2 double loop systems) the frequency range can alternatively be set via the switches 2 / 3 resp. 6 / 7 at the front panel (see also chapter 5). As a result, changing the frequency range via LoopMaster is not possible.

In order to have the best noise immunity, the maximum measurement frequency should be used.

Instructions for setting the frequency with several detectors

Because of the loop control in multiplex mode, the channels of the detector cannot interfere with each other. Thus, the user must only pay attention that the interconnected channels of several detectors have a sufficiently large frequency gap.

An interconnection of detector channels can be the result when the distance between inductive loops is too small and / or when they share the loop feeding. The smaller the distance between the loops and the longer the channels are e.g. lead through a shared feeder cable, the larger is the interconnection.



ATTENTION!

Please observe that the interconnected detectors must work with different frequencies and that additionally the synchronization function must be activated (see chapter 7.5.1).

The difference of measurement frequencies should be approx. 5 - 10 kHz and is normally achieved when different frequency ranges are chosen for several detectors. The channel diagnosis value frequency shows the current measurement frequency (see chapter 7.3.8). This can be used to control the above mentioned minimum frequency gap when the same frequency ranges are set for several detectors.

When several SW2224 are used as a standard for a detection cross section, e.g. on the motorway, we recommend the following procedure to set the frequency.

Normally, 2 resp. 3 lanes per driving direction must be detected. To do so, 4 resp. 6 double loop measurement systems are necessary, which are distributed over the different detectors, i.e. systems with longer feeder cables use lower frequencies and systems with shorter feeder cables use higher frequencies.

Here, it is sensible to set the frequency ranges for both measurement systems of a detector identically.

Detector	1		2	
Driving direction	1		2	
Lane	1	2	1	2
Frequency range	3	3	2	2
Frequency [kHz] (2 channels per system)	92 and 91	86 and 87	66 and 67	77 and 76

Table 5: Example for a motorway with 2 lanes per driving direction

As shown, with 2 lanes it is reasonable to allocate the lanes of one driving direction to one detector. The inductive loops of neighboring lanes of one driving direction don't interfere with each other because of the multiplex mode, the large distances of the inductive loops of different driving directions also avoid interference. If the feeder cables are separate for each driving direction, an interference of the two detectors can be ruled out. If these conditions are not met, different frequency ranges must be used as indicated in the example.

Detector	1		2		3	
Driving direction	1		1 / 2		2	
Lane	1	2*	3*	1**	2**	3
Frequency range	3	3*	2*	2**	1**	1
Frequency [kHz]	86 - 87	92 - 91*	76 - 77*	71 - 72**	55 - 55**	51 - 51

Table 6: Example for a motorway with 3 lanes per driving direction

** / **: possible interference driving direction 1 / 2*

Also in this case the inductive loops of different driving directions cannot interfere with each other either if the feeder cables are separated. Thus, only the inductive loops of neighboring lanes in one driving direction which are controlled by different detectors are subject to a direct interference (values in Table 6 marked in bold). Here, with identical measurement frequencies, an interference of measurement systems would exist because of the sidewise distance of approx. 1.6 m up to 2.0 m. The selected frequency ranges and the resulting measurement frequencies avoid this as far as possible (frequency gap > 5 kHz). Further improvement can be reached by activating the synchronization function (see chapter 7.5).

Limitation of the frequency adjustment

For a loop inductance of approx. 150 µH as usual for ASTRA-SWISS loops and the usage of the feeder cables indicated in the technical data description (see chapter 8.1), the frequency adjustment can be limited if the feeder cable is longer than approx. 150 m. This means that the highest frequency level is no longer adjustable. The alignment fault resulting from this is displayed as "frequency not adjustable" in the LoopMaster and shown at the **ERR** LED and by the channel LED blinking three times. The problem can be solved by reducing the frequency level.

7.1.3 Loop type and loop distance

The parameter loop type is of great importance for the classification. The SW2224 uses separate classification algorithms for each loop type resp. loop length because identical vehicles generate different vehicle patterns with different loop lengths. Thus, for each loop length a separate vehicle pattern database is used in order to reach a very high classification accuracy.

Since the loop length is directly related to the loop type and since it cannot be changed, it is displayed as diagnosis value (see chapter 7.3.1).

For the standard loop type with defined loop distance, the loop distance cannot be changed. Thus, a second loop type with variable loop distance is defined. Here, the parameter loop distance defines the head distance of the loops e.g. from the beginning of the first loop to the beginning of the second one. Values which are too low or too high are automatically limited to the permitted range.



ATTENTION!

In order to reach a highly-precise classification, the loop geometry (length and width) may not differ from ASTRA-SWISS definitions.

7.1.4 Vehicle length correction

An important criterion for the vehicle classification is the detected vehicle length. When a vehicle passes the loop, a vehicle length is determined which is not the actual vehicle length. This so-called “attenuation-length” is partly influenced by the loop length. In order to obtain the real length, a length correction is used. The resulting length is then calculated as follows:

$$\text{real length} = \text{length of attenuation} - \text{length correction}$$

permitted value range length correction: 0 – 20 dm

Changing the length correction value can be necessary in the following cases:

- Strongly diverging loop lengths. In this case, please take into account the strong influence of the actual loop length on the classification accuracy
- Inductive loop laid in greater depth
- Metallic objects (manholes, reinforcement in concrete roads) in a distance of much less than 1 m

Otherwise, when using standard ASTRA-SWISS loops and observing the tolerances and / or geometry and laying depth, no length correction is needed; the correct length correction value is set as default for each loop type resp. loop length.

The adjustment of the length correction may be effected only after a new alignment and the detection of approx. 50 cars. For this, the length value of a car with known length as indicated at the service interface (e.g. VW Golf 4.0 – 4.2 m) must be checked and the length correction must be adjusted until there is an accordance to the known vehicle length. A higher / lower value of the length correction causes a lower / higher value of the real length.

7.1.5 Detection of wrong way drivers

This parameter is used in double loop systems as addition to the integrated detection of the driving direction in order to set the recognition of wrong way drivers. To do so, the “normal” driving direction is determined and when a vehicle passes the loops in the opposite direction, a flag for wrong way drivers is set in the single vehicle telegram. In traffic data acquisition systems this can be used for e.g. alarm messages.

In the single vehicle data of the service interface (see also chapter 6.3) the “normal” driving direction is displayed as “di.”, the wrong way driver as “ww.”.

If the evaluation of direction is turned off, the wrong way driver message on the data and service interface is deactivated.

Detection of wrong way driver	off		“Normal“ driving direction			
			1 st → 2 nd Double loop		2 nd → 1 st Double loop	
Driving direction channel	1 → 2 resp. 3 → 4	2 → 1 resp. 4 → 3	1 → 2 resp. 3 → 4	2 → 1 resp. 4 → 3	1 → 2 resp. 3 → 4	2 → 1 resp. 4 → 3
Service interface: Single vehicle readout	di.0	di.1	di.0	ww.1	ww.0	di.1
Data interface: Wrong way driver flag single vehicle telegram	0	0	0	1	1	0

Table 7: Overview wrong way driver detection: Parameterizing and data readout

7.1.6 Address data bus

The address is part of the manufacturer-specific protocol. For each detection system, an individual unique address is necessary. Without wiring the address inputs at the connecting strip (see chapter 8.3), this parameter determines the addresses of the measurement system at the data bus. If the addressing inputs are used, here the addresses automatically evaluated from this hardware address are displayed. See also chapters 7.2.3 and 7.4.1.

7.1.7 Sensitivity / measuring time

In contrast to detectors for traffic signal installations, the adjustment of these parameters is limited, because they have great influence on the accuracy of the vehicle detection (e.g. classification and speed measurement).

Therefore, the sensitivity cannot be changed. The SW2224 has an automatic sensitivity adjustment and very short measurement times in order to ensure optimum single vehicle detection also at high speeds.

When the detector is delivered, the measurement time is optimally set for the application and usually does not need to be changed.

7.1.8 Hold time

The hold time is initiated during each detection. If the hold time elapses without the channel becoming free, the channel will be reset. If a vehicle is still on the loop at this point in time, this vehicle will be ignored.

If the vehicle leaves the loop afterwards, the original sensitivity is reached at approx. 4 s after leaving the loop. Further vehicles restart this time period.

With static hold time (infinite hold time), external interferences may reduce the actually achievable hold time. Setting a finite hold time generally ensures reliable operation in these cases. Still, the requirements of traffic data acquisition, which don't permit a short hold time, must be observed (e.g. detection of congestions).



NOTE

If congestion detection is necessary due to traffic data acquisition requirements, the default "infinite hold time" must not be changed.

The channel alignments initiated by exceeded hold times are displayed in the channel diagnostic value in the (see chapter 7.3.6).

7.1.9 Channel flags

The channel flags are used to configure the following binary channel parameters:

- Automatic recalibration in case of channel error (for functionality see chapter 6.2)
- Contact position of the switching outputs
- Contact position in case of an error

The **contact position of the switching outputs** (electronic relays and open collector) can be influenced in the following manner:

- **Normally Open (NO):** open collector HIGH / relay contact open when loop not occupied (factory setting),
- **Normally Closed (NC):** open collector LOW / relay contact closed when loop not occupied

On detection, the relay contact and open collector switch to the respective other position.

The **contact position in case of an error** in the channel can be adjusted as follows:

- Switching output as loop unoccupied
- Switching output as loop occupied (factory setting)

7.1.10 Maximum loop alignment duration

Under unfavorable application conditions, the alignment duration of a channel may be considerably longer as a result of external interferences. This parameter limits the alignment duration per channel to the indicated value and sets the channel to fault, in order to prevent unreliable detection behavior. This function is deactivated with the value 0. On activating the function "Automatic alignment case of error", a new alignment attempt is cyclically (1 min) initiated.

7.1.11 Noise threshold

The noise threshold defines, to what extent the disturbing signal might have an influence on the detection and the temperature compensation. The loop measurement signal is superposed with disturbing signals resp. a noise. Reasons for this can be interferences from other induction loops or external disturbing signals. The smaller this value, the higher is the sensitivity to disturbances; the higher this value, the better interferences are suppressed. However, higher noise threshold values can have a negative influence on the internal measurement value resolution. As a function of the automatically evaluated switch on threshold, the values of the noise threshold are limited to the permitted minimum and maximum values.

The default values should only be changed in exceptional cases if the detector function is strongly influenced by interferences. In this case, the noise threshold must be raised step by step.

7.2 Significance of the device parameters

The device parameters are settings that affect several or all channels of the detector and are transmitted together with the channel data between the LoopMaster and the detector.

7.2.1 Language service interface

With this parameter, the text readouts on the service interface (e.g. vehicle data) can be switched to the desired language. Please note that this does not change the language setting in the LoopMaster operating program.

7.2.2 Baud rate data bus

With this parameter, the baud rate of the data interface can be set. Usually, the default setting of 9600 baud is sufficient. The set baud rate must be consistent with the baud rate used by the data bus master.

7.2.3 Detector flags

The following settings can be configured:

- Detector synchronization: MASTER / SLAVE
- Backplane-address data bus: Enabled / Disabled

If several detectors are to be synchronized with one another in order to avoid their mutual interaction, the MASTER setting must be configured here for **just one** detector. For further information concerning **synchronization** see chapter 7.5.

The backplane address can be locked by the setting "**Backplane-address data bus: Disabled**" (see chapter 7.4). In this case the data bus address defined in the channel parameters is used (see chapter 7.1.6). Addressing via backplane can be deactivated to allow an addressing independent from the backplane. With modification of this flag, a detector reset is performed.

7.2.4 LED turn-off time

After the LED turn-off time has elapsed, the LEDs are switched off. Briefly pressing the pushbutton or communicating via the service interface reactivates the LEDs. The value 0 deactivates the turn-off function.

7.3 Significance of the channel diagnostic values

These values are generated for each channel by the detector during operation. The values indicated apply for the time of parameter request; if necessary, they are to be updated by means of parameter request from the detector.

7.3.1 Loop length

The loop length is directly related to the loop type and is displayed as unchangeable diagnosis value.

7.3.2 Extended channel flags

The extended channel flags are a supplement to the channels flags described in chapter 7.1.9.

At the moment there are no adjustable flags defined for the SW2224, therefore, these flags are diagnosis value and cannot be changed.

In the standard version of the SW2224 (double loop system), this configuration is displayed as "Double loop function (v, l, dir.): On" and measurements of speed (v) and length (l) as well as detection of direction (dir.) are possible.

7.3.3 Channel status

The channel status contains the following binary data:

- Channel occupied: current detection status (detection yes / no)
- Channel error: current error status (error yes / no)
- Channel error history (since POR): channel was previously disturbed (yes / no).

The "Channel error history (since POR):" flag is reset in case of a **Power On Reset** (abbreviation: POR, i.e. reset on switching on the supply voltage).

7.3.4 Vehicle classification

The vehicle classification displays the classification options set as default. The following options are available acc. to ASTRA:

- Standard: SWISS10
- Option 1: SSVZ
- Option 2: car-similar / HGV-similar vehicles

7.3.5 Channel error

In case of a channel error, the channel error displays the error causes evaluated by the detector during alignment (see chapter 6.2).

7.3.6 Alignment counter and hold time exceedance

This value indicates the alignment processes performed since the last POR. This can be alignment processes initiated by parameter modification, RESET conditions or alignments caused by error conditions during loop operation. This information may therefore contribute to error detection, since unreliably operating loop channels and devices can be detected here.

The number of exceeded hold times is indicated in a separate counter and is also included in the number of (total) alignments. In the default setting of the hold time (infinite) there are no exceeded hold times possible.

These values can be reset using the LoopMaster menu item: "Reset counter".

7.3.7 Inductance

The inductance of the inductive loop (including feeder cable!) is indicated in μH with a resolution of $10 \mu\text{H}$. The inductance is determined with an accuracy of approx. $\pm 20\%$ within the recommended inductance range. The position of the frequency jumper is automatically considered.

7.3.8 Frequency

The frequency indicated here in kHz lies within the set frequency range and is used e.g. for controlling the frequency gaps to channels of other detectors (see **Instructions for setting the frequency with several detectors** in chapter 7.1.2).

7.3.9 Turn-on threshold, maximum and last amplitude

All these values are displayed in the unit [%] and can therefore be directly related to one another and to the nominal value:

- The turn-on threshold is automatically evaluated from the norm value.
- Example relation turn-on threshold – last amplitude:
last amplitude 1.200 %,
turn-on threshold 0.100 %:
i.e. the last vehicle had a maximum detuning value which was 12 times higher than the turn-on threshold.

If the value exceeds resp. falls below the **turn-on threshold** the "channel occupied" resp. "channel not occupied" message is issued on the channel LED and the switching output.

The **maximum attenuation** indicates the maximum detuning since the last alignment and should be approx. 2 – 3 times of the norm value.

These values can be reset using the LoopMaster menu item: "Reset counter"

7.3.10 Norm value

This diagnosis value indicated the average value of the attenuation amplitudes of cars in the unit [%] and is used to control the automatic calibration (see also chapter 6.3).

7.3.11 Alignment cause

The alignment cause indicates the reasons for the numbers indicated in the alignment counter and hold time exceedance:

- **Exceedance of measurement value:**
Cause e.g. for a following channel fault loop open or short-circuited
- **Norm value beyond the permitted range:**
If the detected norm value is too low during the automatic calibration (see chapter 6.3), the calibration is restarted with the basic settings. If this error repeatedly occurs, the error cause (e.g. loop feeder cable too long, road or bridge reinforced by iron, loops are passed diagonally due to road works) must be evaluated and, if possible, eliminated.
- **Error other system channel, system alignment:**
In a double loop system (channel 1, 2 resp. 3, 4), the alignment was initiated by the according other channel.
- **Exceedance of hold time:**
Due to the exceeded hold time, an alignment was performed for the channel and the counter for hold time exceedance was increased.

- **Operation (interface, switch):**
The alignment was initiated by the user by pressing the reset pushbutton or by parameter modification by means of LoopMaster.
- **Synchronization:**
An alignment was initiated by a modification in synchronization (see chapter 7.5).
- **Monitoring of double loop system:**
In a double loop system, the two channels monitor each other. If one channel notices a malfunction of the other channel (e.g. caused by “get stuck”), an alignment of the loop system will be performed.

These values can be reset using the LoopMaster menu item: "Reset counter"

7.4 Significance of the device diagnostic values

These values are generated by the detector during operation. The values displayed are valid for the time of parameter request. If necessary, they are to be updated with a parameter request from the detector.

7.4.1 Backplane address data bus

Here, the address is displayed, which is determined by the circuitry of addressing inputs e.g. on the backplane (details see chapter 8.3). When the backplane address is activated, the data bus addresses of the measurement systems are automatically evaluated from the backplane address.



NOTE

The backplane address indicates the start value of the addresses for this detector. For each existing measurement system a further address is used.

Examples:

- 4-channel detector with 2 double loop measurement systems, backplane address 3:
System 1 (channel 1 and 2): address 3,
System 2 (channel 3 and 4): address 4
- 4-channel detector with 4 single loop measurement systems, backplane address 5:
System 1 (channel 1): address 5,
System 2 (channel 2): address 6,
System 3 (channel 3): address 7,
System 4 (channel 4): address 8

The backplane addressing can additionally be deactivated via detector flag (see chapter 7.2.3), e.g. if the automatic allocation of addresses is not intended.

The backplane addressing is deactivated by the according wiring of the addressing inputs (all inputs HIGH or not connected). Then, the address of the measurement system as saved in the EEPROM is used (see chapter 7.1.6).

7.4.2 Front panel switches

This diagnosis value indicates the positions of the DIP-switches provided at the front panel. For further information about the function of the switches see chapter 5.

7.4.3 Reset counter, reset cause

The value reset cause indicates in bit-coded form the reason for the reset, the reset counter indicates the number of resets since the last POR. These values can be reset using the LoopMaster menu item: "Reset counter"

7.4.4 Cycle time

The cycle time in ms is the sum of the total measuring times of all channels (chapter 7.1.7):

$$\begin{aligned} \text{Cycle time} = & \text{measuring time, channel 1} \\ & + \text{measuring time, channel 2} \\ & + \text{measuring time, channel 3} \\ & + \text{measuring time, channel 4.} \end{aligned}$$

When the synchronization function is activated, the cycle time is the sum of the accordingly longest channel measurement times of all synchronized detectors. Please note that the cycle time should not exceed 8 ms.

7.5 Description of the special functions

7.5.1 Synchronization

If setting different frequency ranges (see chapter 7.1.2) alone does not lead to decoupling, the synchronization function can be used to minimize or eliminate e.g. false detections with detectors which are interconnected via loop feeder cable or in a direct way. The synchronization function ensures that the same channel is measured at all connected devices at any point of time.

When connecting the inductive loops the following must be observed: The inductive loops with small distance to each other must not be connected to channels with the same channel number. Different channel measurement times are automatically taken into account by using the longest measurement time of the according channel group to determine the total measurement time of the channel. If systems are interconnected in an especially strong way, additionally different frequency ranges must be used.

To activate the synchronization first the synchronization lines must be connected at the terminal strip (respectively b6 and b8) at all detectors (maximum 30 devices). Additionally, exactly one detector must be defined as MASTER. All other devices must remain in the default setting SLAVE.



ATTENTION!

Configuration of several MASTERS is not permitted!

For SLAVE detectors, that are already synchronized with a MASTER, the activation of the MASTER function will automatically be prevented.

The MASTER-SLAVE function is a device parameter and is to be found in the corresponding LoopMaster parameter window. The setting is transmitted to the detector by the command "Write to device..." and by selecting a channel.

When the MASTER-SLAVE setting is changed no RESET is executed and the traffic data acquisition is not interrupted. The start and the end of the SLAVE-synchronization is performed as part of an alignment of all channels of the SLAVE units if:

- a MASTER is activated when synchronization is not yet activated (start of synchronization)
- the MASTER executes a reset (start of synchronization)
- the MASTER is deactivated while synchronization is activated (end of synchronization)

After all detectors have finished the initialization of synchronization and the channel alignment, all **FCT** LEDs flash synchronously with a frequency of 0.5 Hz, however, the ones of the MASTER inversely to the SLAVE units.

7.5.2 Notes concerning the data bus function

Data readout is performed via RS485 data bus interface in a master/slave polling mode. The protocol to be used by the controller (master) for requesting the detectors (slaves) and the data contents are defined in a separate descriptions, further specifications of the data bus interface are listed in the technical data (see chapter 8.1). The protocol description "Manufacturer-specific telegram definition" is available on request.

At the detector, the RS485 bus can be terminated with a termination resistance of **120 Ω**. For this purpose, there is a plug jumper (labeled „TERM1“) on the detector in front of the connecting strip. The termination resistance is activated in position 1 – 2 (direction front panel) and deactivated in position 2 – 3.



NOTE

In the default setting the jumper is in position 2 – 3, i.e. the RS485 bus is not terminated by this detector! Activate the termination once on the detector at the end of a RS485 bus line.

With lower baud rates (e.g. in default setting 9600 baud) and with short data bus lengths (e.g. within a rack), usually no termination is necessary.

8 Appendix

8.1 General technical data

Technical Data	
Supply voltage	Standard: 5 V DC +/- 5 % (regulated and load-independent) optional: 10 V DC - 38 V DC on request
Power consumption	max. 90 mA / 0.45 W (5 V DC)
Loop frequency range	30 kHz – 110 kHz
RS485 interface (terminal strip, connection see chapter 8.3)	9600 baud, 11-bit transmission frames, 8 data bits, even parity, 1 start bit, 1 stop bit transmission procedures in accordance with IEC-870, asynchronous, half-duplex, manufacturer-specific telegram content available on request Terminal resistance 120 Ω adjustable via jumper
RS232 service interface (at front, "SERVICE")	Connecting cable: DSUB 9-pole, 1:1 connection, socket-socket
Switching outputs	switching output per channel: Open Collector (not potential free) Common error output: Open Collector (not potential free) Optional: electronic relay contact (potential free) For further technical data see chapter 8.2
Max. length of feeder cable	approx. 300 m for ASTRA-SWISS loop type (approx. 25 Ω), values apply to indicated loop induction ranges and the following cable types: A-2Y (L) 2Y Zx2x0,8 BdStIII or A-2YF (L) 2Y Zx2x0,8 BdStIII (Ø 0,8 mm, Z e.g. 2, 10) optional: feeder cable lengths up to approx. 600 m (on request)
Duration of loop measurement	1.5 ms per channel / 6.0 ms for 4 channels
Definition of inductive loops to be used	ASTRA-SWISS L x B: 2.0m x 2.0m (distance to median strip 0,8 / 1,0m) head distance: 5.0 m Number of windings: 4 Inductance range: 140 - 165 µH (with above mentioned data of inductive loops)
Total inductance (incl. feeder cable)	Maximum approx. 500 µH (for 300 m feeder cable with above mentioned inductive loops and cable types)
Ohmic resistance (loop and feeder cable)	Maximum 25 Ω
Isolation resistance of loops (without feeder cable)	At installation: > 1GΩ During operation: Values as low as approx. 1 MΩ are permitted, value must be constant

Technical Data – continued	
Device protection ²	Power supply, RS485: suppression diodes Loop inputs: glow lamps, galvanic separation by isolating transformer
Dimensions	height: 128 mm, length: 190 mm, width: 20 mm (4 TE), optional 40 mm (8 TE)
Operating / storage temperature	-25°C to +80°C / -40°C to +80°C
Relative humidity	maximum 95 %, noncondensing
Protection class	III (low voltage < 60 V DC)
Design	plug-in card for 19" rack, to be installed in housing or cabinet with IP54 necessary (pollution degree 2)
Terminal strip	Multipoint connector DIN 41612, see chapter 8.3
Weight	approx. 150 g

8.2 Technical data of switching outputs

Open Collector (standard)	Electronic relay (optional)
$U_{\max} = 48 \text{ V DC}$	$U_{\max} = 40 \text{ V}_{\text{eff AC}} / 48 \text{ V DC}$
$I_{\max} = 150 \text{ mA DC}$	$I_{\max} = 200 \text{ mA AC}_{\text{Peak}} / \text{DC}$
$P_{\text{tot}} = 125 \text{ mW}$	$P_{\text{tot}} = 250 \text{ mW}$
$I_c \leq 20 \text{ mA}$: $U_{\text{cesat}} \leq 0,4 \text{ V}$	$R_{\text{On}} < 5,0 \Omega$
Not potential free	potential free

² This is only an overvoltage protection! Additional measures (coarse protection) must be provided! (see chapter 3.2)

8.3 Pin assignment multipoint connector (DIN41612 type F and C)

Standard: Type F: 48-pole multipoint connector, rows d / b / z
 Optional: Type C: 32-/48-pole multipoint connector, rows a / b**** / c

	d b z	d (c)	b ****	z (a)
2		Inductive loop 2	FE	Inductive loop 1
4		Inductive loop 4	FE	Inductive loop 3
6		Inductive loop 2	Synchronization 1	Inductive loop 1
8		Inductive loop 4	Synchronization 2	Inductive loop 3
10		CH2 output -*	Address bit 1 ***	CH1 output -*
12		CH4 output -*	Address bit 2 ***	CH3 output -*
14		CH2 output +*	Address bit 3 ***	CH1 output +*
16		CH4 output +*	Address bit 4 ***	CH3 output +*
18		Slot control bridged with d20	Address bit 5 ***	RS485 A
20		Slot control bridged with d18	Address bit 6 ***	RS485 B
22	--- ---	reserved	reserved	reserved
24		n.c.	I2C-SDA (ext. EEPROM)	n.c.
26		n.c.	I2C-SCL (ext. EEPROM)	n.c.
28		RESET extern**	Collective error output -*	Collective error output+*
30		Output 3.3 V DC (e.g. for ext. EEPROM)	n.c.	reserved (VBat)
32		0 V DC	FE	+5 V DC

Rear view on the device connector

- *: for electronic relay: potential free AC / DC outputs
- *: for open collector: +: collector, -: not wired (not potential free: reference 0 V, device ground)
- ** : Low-active (0 V DC) initiates RESET (static), maximum 5 V DC
- ***: Slot addressing data interface RS485:
Address bit HIGH: connect with 0 V DC (d32) ; Address bit LOW: open
- ****: not applicable with type C, 32-pole
- (OC): Open Collector
- : bridged
- FE: Functional Earthing (Overvoltage protection inductive loop inputs)
- reserved: Connections must not be wired!
- Synchronization 1 resp. 2: Only direct connection to pins Synchronization 1 resp. 2 of further identical detector types is permitted. No additional wiring permitted. Maximum length approx. 1 m.

8.4 Pin assignment service interface (DSUB 9-pole, plug)

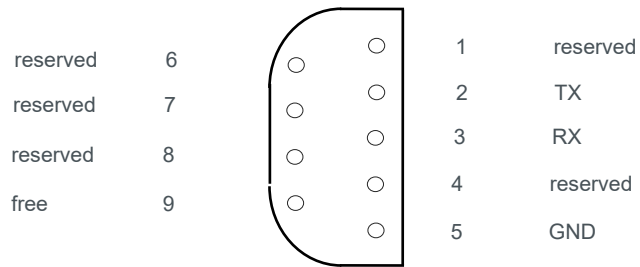

8.5 Dimensions

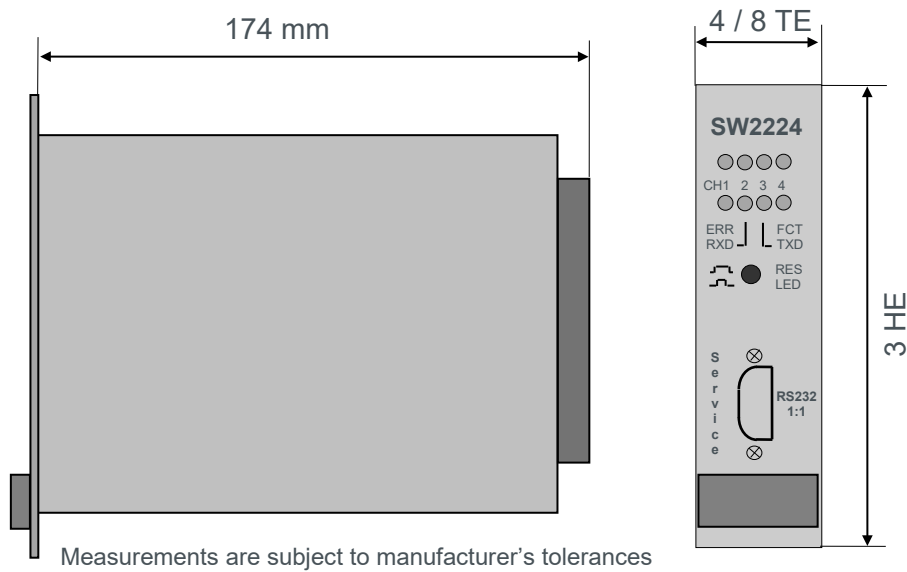

8.6 Requirements for the usage according to regulations

According to DIN EN 60950

The basic insulation of the device requires an exclusive connection of low voltage supply and switching voltages **below 60 V DC**. In addition, the power supplies used for the safe isolation must assure double or reinforced insulation between mains circuits and output voltage.

In compliance with the underlying pollution degree 2 the installation in an enclosure or control panel with at least IP54 is required.

If the device is to be exposed surges above the overvoltage category II, then additional surge protection have to be installed.

According to EN 50293

The length of the connected lines, except for the inductive loops, must not exceed 3 m.

Requirements according to ETSI EN 300330-1

For the antenna factor (loop area A in m² multiplied by the number of loops turns N) applies:
 $N * A \leq 60 \text{ m}^2$

The loop type to be used (ASTRA-SWISS) and the product class 2 ($A < 30 \text{ m}^2$, $N > 1$) to be applied meet the requirements.

Installation of loops

For the installation of the inductive loops the regulations of ASTRA and the documentation "Loop Installation TLS" by SWARCO TRAFFIC SYSTEMS GMBH apply.

8.7 EC Conformity

EU-Konformitätserklärung EU-Declaration of Conformity

Inverkehrbringer / distributor: Swarco Traffic Systems GmbH

Adresse / address: Niederkircher Str. 16

54294 Trier

erklärt, dass das Produkt / declares that the product

Typ / type: Induktiver Schleifendetektor / inductive loop detector

Modell / model: SW2224 Series

Verwendungszweck / intended use: Fahrzeugdetektion / vehicle detection

bei bestimmungsmäßiger Verwendung den grundlegenden Anforderungen gemäß

- RED - Richtlinie 2014/53/EU und
- RoHs 2011/65/EU

entspricht und dass die folgenden Normen angewandt wurden:

complies with the essential requirements of the RED 2014/53/EU Directive and RoHs 2011/65/EU, if used for its intended use and that the following standards has been applied:

1 Sicherheit / Gesundheit (Artikel 3.1.a der RED-Richtlinie)
safety / health (Article 3.1.a of the RED Directive)

Angewandte Norm(en) /	IEC 62368-1	2014 (2. Ed.)/Cor.1:2015
Applied standard(s):	EN 62368-1	2014/AC: 2015/A11:2017/AC:2017

2 Elektromagnetische Verträglichkeit (Artikel 3.1.b der RED-Richtlinie)
electromagnetic compatibility (Article 3.1.b of the RED Directive)

Angewandte Norm(en) /	ETSI EN 301 489-1	V2.2.3
Applied standard(s):	ETSI EN 301 489-3	V2.1.1
	EN 50293	2000-12

3 Effiziente Nutzung des Funkfrequenzspektrums (Artikel 3.2 der RED-Richtlinie)
efficient use of the radio frequency spectrum (Article 3.2 of the RED Directive)

Angewandte Norm(en) /	ETSI EN 300 330-1	V1.5.1
Applied standard(s):	ETSI EN 300 330-2	V1.3.1

Trier, 16.11.2021

(Ort und Datum der Konformitätserklärung)
(Place and date of the declaration of conformity)

Ralf Biesenberger
(Ralf Biesenberger)
(authorised officer)

Frank Weyhmüller
(Frank Weyhmüller)
(authorised officer)

SWARCO TRAFFIC SYSTEMS GMBH
Niederkircher Straße 16
D-54294 Trier
www.swarco.com/sts

© 2023 Alle Rechte vorbehalten

Thank you for choosing a SWARCO TRAFFIC SYSTEMS GMBH quality product.